

SPACERS

Drawings are not to scale

Metric spacers are black oxidized

Slots and holes are centered unless otherwise noted

DSCP058 Series Spacers

DSC Part No. Thickness Other part numbers

DSCP058-E062..... .062 inch..... FSD 14131-51
 DSCP058-E125..... .125 inch..... FSD 14131-52

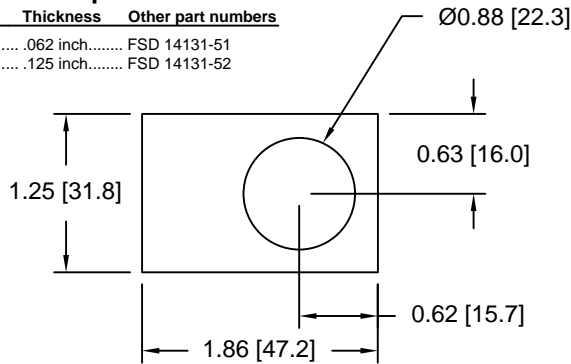

DSCP059 Series Spacers

DSC Part No. Thickness Other part numbers

DSCP059-E062..... .062 inch..... FSD 14136-51
 DSCP059-E125..... .125 inch..... FSD 14136-52

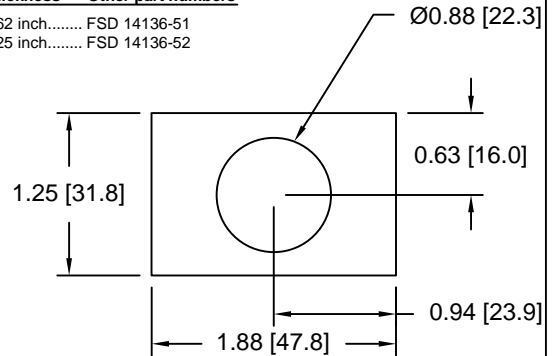

DSCP060 Series Spacers

DSC Part No. Thickness Other part numbers

DSCP060-E062..... .062 inch..... FSD 14137-51
 DSCP060-E125..... .125 inch..... FSD 14137-52

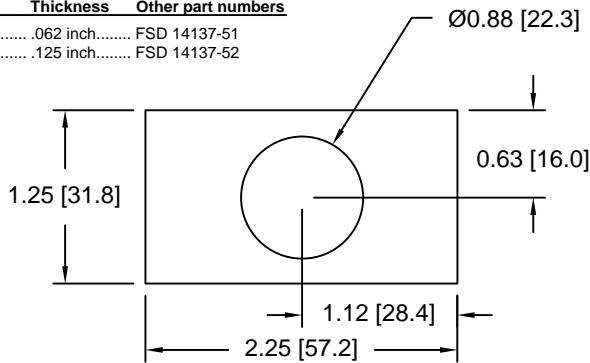

DSCP061 Series Spacers

DSC Part No. Thickness Other part numbers

DSCP061-E062..... .062 inch..... FSD 14138-51
 DSCP061-E125..... .125 inch..... FSD 14138-52

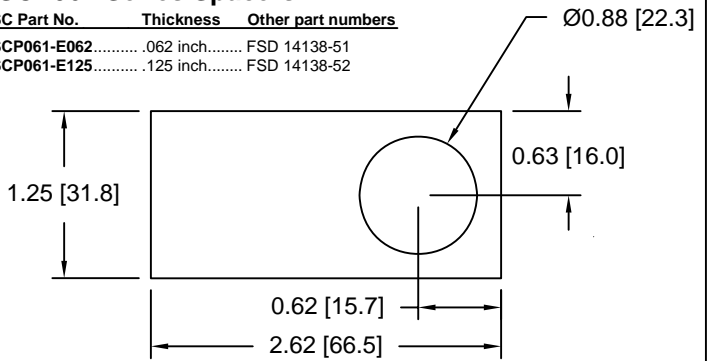

DSCP062 Series Spacers

DSC Part No. Thickness Other part numbers

DSCP062-E062..... .062 inch..... FSD 14139-51
 DSCP062-E125..... .125 inch..... FSD 14139-52

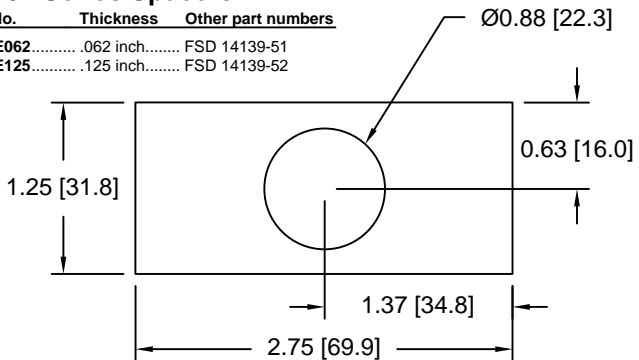

DSCP063 Series Spacers

DSC Part No. Thickness Other part numbers

DSCP063-E062..... .062 inch..... FSD 14140-51
 DSCP063-E125..... .125 inch..... FSD 14140-52

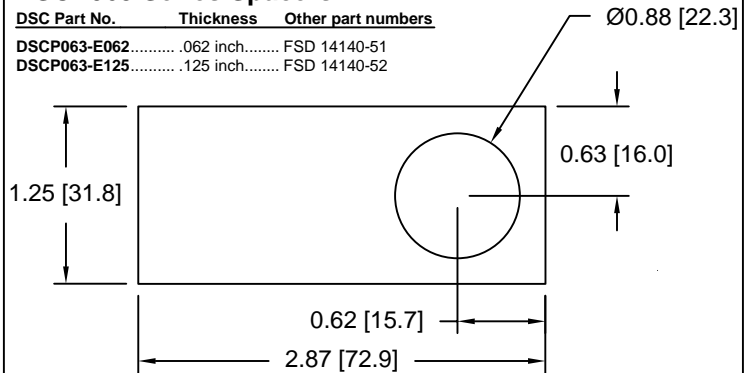

DSCP064 Series Spacers

DSC Part No. Thickness Other part numbers

DSCP064-E062..... .062 inch..... FSD 14141-51
 DSCP064-E125..... .125 inch..... FSD 14141-52

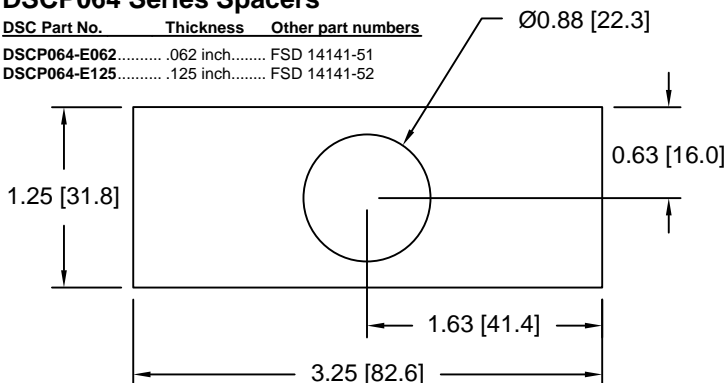

DSCP065 Series Spacers

DSC Part No. Thickness Other part numbers

DSCP065-E062..... .062 inch..... FSD 14142-51
 DSCP065-E125..... .125 inch..... FSD 14142-52

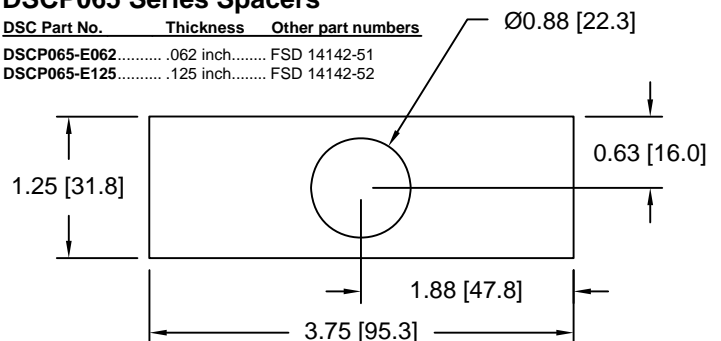

Douglas Stamping Company (248) 542-3940 FAX (248) 542-6342

<http://dougstampco.com> sales@dougstampco.com