

DSCH073 Series Shims

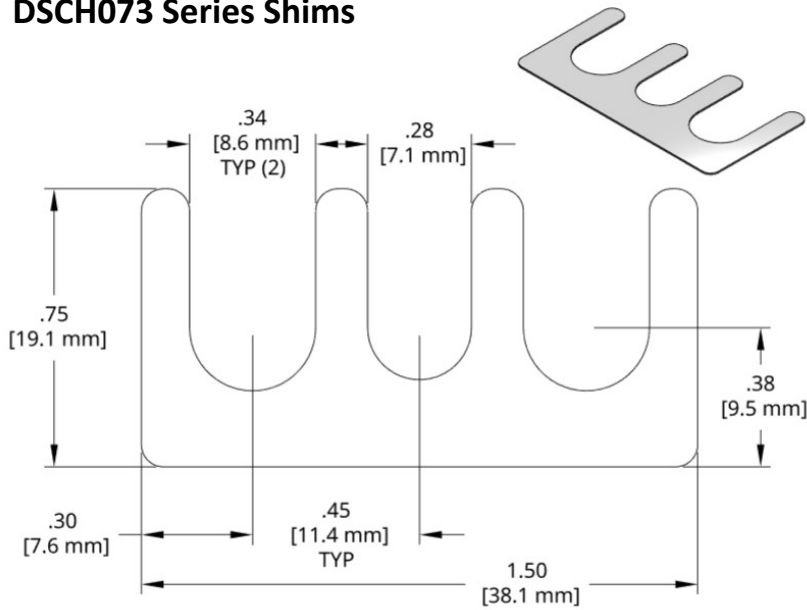

Individual Shim	Thickness
DSCH073-M025	.25 mm
DSCH073-M050	.50 mm
DSCH073-M100	1.00 mm
DSCH073-M200	2.00 mm
DSCH073-E015	.015 inch
DSCH073-E032	.032 inch
DSCH073-E062	.062 inch

Full Hard 1010 steel shim stock. Black Oxide finish on -M050, -M100 and -M200 thickness shims.

Add a **K** to the end of the Bulk Set number for assembled (kitted) sets.

Bulk Set	Thick	Set Includes
DSCH073-M305	3.0mm	(0) 2.00mm, (2) 1.00mm, (1) .50mm, (2) .25mm
DSCH073-M454	4.5mm	(1) 2.00mm, (2) 1.00mm, (1) .50mm, (0) .25mm
DSCH073-M505	5.0mm	(1) 2.00mm, (2) 1.00mm, (2) .50mm, (0) .25mm
DSCH073-M506	5.0mm	(1) 2.00mm, (2) 1.00mm, (1) .50mm, (2) .25mm
DSCH073-M507	5.0mm	(1) 2.00mm, (1) 1.00mm, (3) .50mm, (2) .25mm
DSCH073-M605	6.0mm	(2) 2.00mm, (1) 1.00mm, (2) .50mm, (0) .25mm
DSCH073-M706	7.0mm	(2) 2.00mm, (2) 1.00mm, (2) .50mm, (0) .25mm
DSCH073-E255	.25 inch	(3) 0.062in, (2) 0.032in

DSCH074 Series Shims

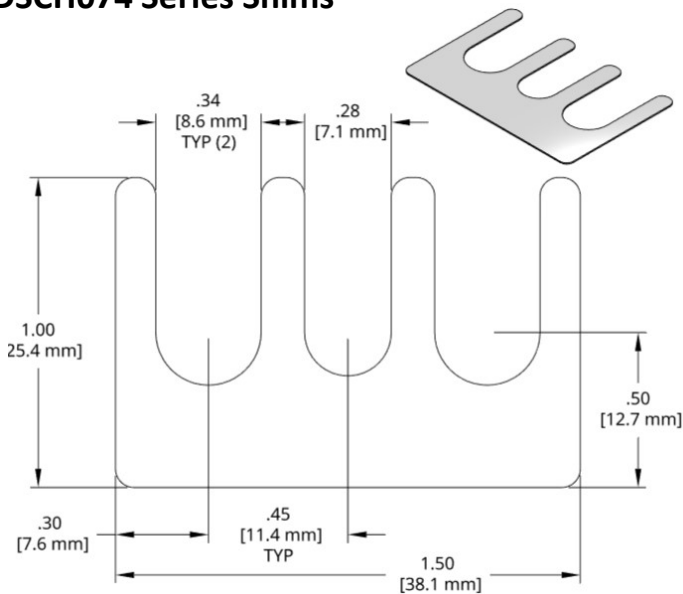

Individual Shims	Thickness
DSCH074-M025	.25 mm
DSCH074-M050	.50 mm
DSCH074-M100	1.00 mm
DSCH074-M200	2.00 mm
DSCH074-E015	.015 inch
DSCH074-E032	.032 inch
DSCH074-E062	.062 inch

Full Hard 1010 steel shim stock. Black Oxide finish on -M050, -M100 and -M200 thickness shims.

Add a **K** to the end of the Bulk Set number for assembled (kitted) sets.

Set	Thick	Set Includes
DSCH074-M305	3.0mm	(0) 2.00mm, (2) 1.00mm, (1) .50mm, (2) .25mm
DSCH074-M454	4.5mm	(1) 2.00mm, (2) 1.00mm, (1) .50mm, (0) .25mm
DSCH074-M505	5.0mm	(1) 2.00mm, (2) 1.00mm, (2) .50mm, (0) .25mm
DSCH074-M506	5.0mm	(1) 2.00mm, (2) 1.00mm, (1) .50mm, (2) .25mm
DSCH074-M507	5.0mm	(1) 2.00mm, (1) 1.00mm, (3) .50mm, (2) .25mm
DSCH074-M605	6.0mm	(2) 2.00mm, (1) 1.00mm, (2) .50mm, (0) .25mm
DSCH074-M706	7.0mm	(2) 2.00mm, (2) 1.00mm, (2) .50mm, (0) .25mm
DSCH074-E255	.25 inch	(3) 0.062in, (2) 0.032in