

DSCH099 Series Shims

Individual Shim	Thickness
DSCH099-M025	.25 mm
DSCH099-M050	.50 mm
DSCH099-M100	1.00 mm
DSCH099-M200	2.00 mm
DSCH099-E015	.015 inch
DSCH099-E032	.032 inch
DSCH099-E062	.062 inch

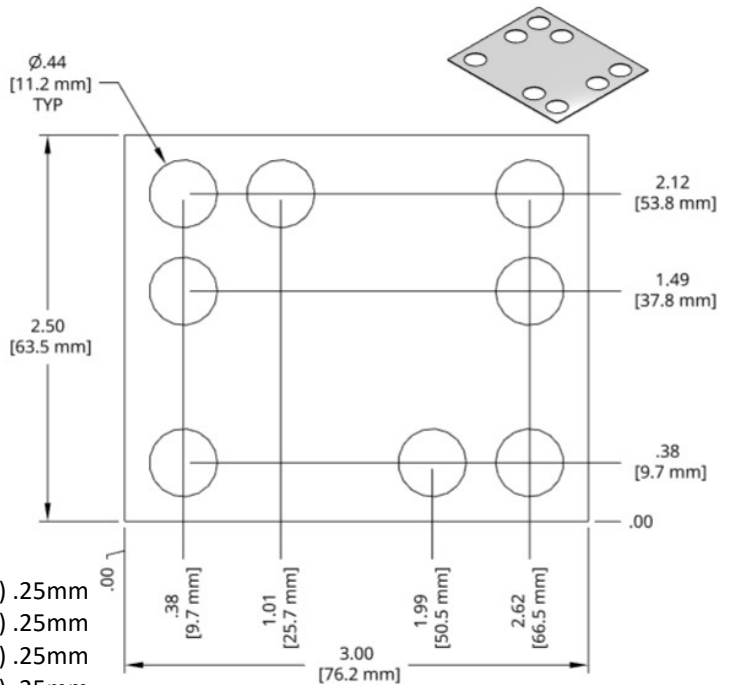

Full Hard 1010 steel shim stock.

Add a **K** to the end of the Bulk Set number for assembled (kitted) sets.

Bulk Set	Thick	Set Includes
DSCH099-M305	3.0mm	(0) 2.00mm, (2) 1.00mm, (1) .50mm, (2) .25mm
DSCH099-M454	4.5mm	(1) 2.00mm, (2) 1.00mm, (1) .50mm, (0) .25mm
DSCH099-M505	5.0mm	(1) 2.00mm, (2) 1.00mm, (2) .50mm, (0) .25mm
DSCH099-M506	5.0mm	(1) 2.00mm, (2) 1.00mm, (1) .50mm, (2) .25mm
DSCH099-M507	5.0mm	(1) 2.00mm, (1) 1.00mm, (3) .50mm, (2) .25mm
DSCH099-M605	6.0mm	(2) 2.00mm, (1) 1.00mm, (2) .50mm, (0) .25mm
DSCH099-M706	7.0mm	(2) 2.00mm, (2) 1.00mm, (2) .50mm, (0) .25mm
DSCH099-E155	.150 inch	(1) .062in, (2) .032in, (2) .015in
DSCH099-E255	.25 inch	(3) 0.062in, (2) 0.032in

DSCH100 Series Shims

Individual Shim	Thickness
DSCH100-M025	.25 mm
DSCH100-M050	.50 mm
DSCH100-M100	1.00 mm
DSCH100-M200	2.00 mm
DSCH100-E015	.015 inch
DSCH100-E032	.032 inch
DSCH100-E062	.062 inch

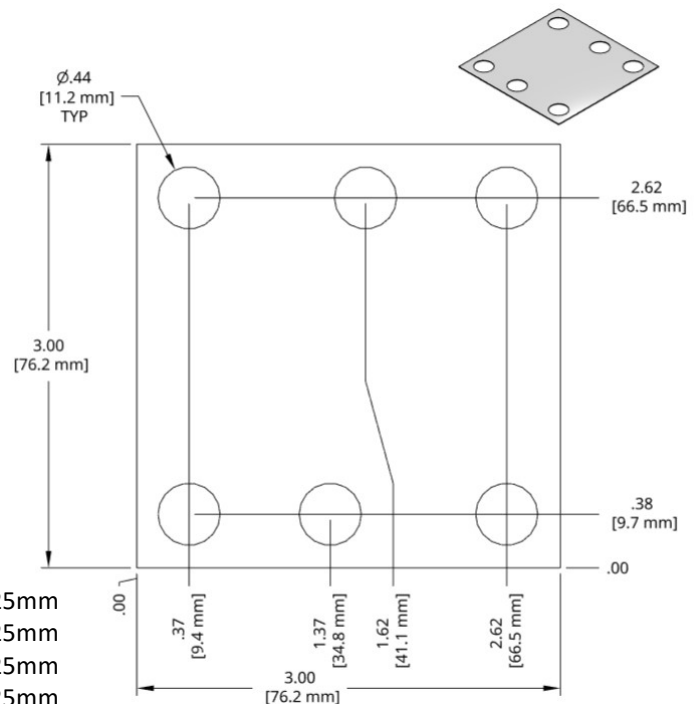

Full Hard 1010 steel shim stock.

Add a **K** to the end of the Bulk Set number for assembled (kitted) sets.

Bulk Set	Thick	Set Includes
DSCH100-M305	3.0mm	(0) 2.00mm, (2) 1.00mm, (1) .50mm, (2) .25mm
DSCH100-M454	4.5mm	(1) 2.00mm, (2) 1.00mm, (1) .50mm, (0) .25mm
DSCH100-M505	5.0mm	(1) 2.00mm, (2) 1.00mm, (2) .50mm, (0) .25mm
DSCH100-M506	5.0mm	(1) 2.00mm, (2) 1.00mm, (1) .50mm, (2) .25mm
DSCH100-M507	5.0mm	(1) 2.00mm, (1) 1.00mm, (3) .50mm, (2) .25mm
DSCH100-M605	6.0mm	(2) 2.00mm, (1) 1.00mm, (2) .50mm, (0) .25mm
DSCH100-M706	7.0mm	(2) 2.00mm, (2) 1.00mm, (2) .50mm, (0) .25mm
DSCH100-E155	.150 inch	(1) .062in, (2) .032in, (2) .015in
DSCH100-E255	.25 inch	(3) 0.062in, (2) 0.032in